

# HIGH CURRENT AND HIGH BRIGHTNESS ELECTRON SOURCES

F. Loehl\*, I. Bazarov, S. Belomestnykh, M. Billing, E. Chojnacki, Z. Conway,  
 J. Dobbins, B. Dunham, R. Ehrlich, M. Forster, S. M. Gruner, C. Gulliford, G. Hoffstaetter,  
 V. Kostroun, M. Liepe, Y. Li, X. Liu, H. Padamsee, D. Rice, V. Shemelin, E. Smith, K. Smolenski,  
 M. Tigner, V. Veshcherevich, Z. Zhao  
 CLASSE, Cornell University, Ithaca, NY 14853, USA

## Abstract

The development of high current, high brightness electron guns is critically important for free-electron laser and energy recovery linear-accelerator light source facilities. In this paper, we will review the technical requirements of such projects and the status of on-going research throughout the community including results of emittance measurements and high current beam performance.

## INTRODUCTION

The average brilliance of free-electron laser (FEL) and energy recovery linear-accelerator (ERL) light source facilities is proportional to the average beam current in the accelerator. In order to achieve tolerable gain lengths in FELs operating in the soft and hard x-ray regime, the electron source has to deliver a very low beam emittance. The same requirement holds for possible future, ERL driven x-ray FELs. A low beam emittance is also required in x-ray ERLs in which the electrons emit their radiation incoherently, since the spectral brightness and coherence of the light beam increases with a decreasing electron beam emittance.

Conventional normal-conducting radio frequency (RF) guns operated at a low duty factor in a pulsed mode have proven to deliver exceptionally bright electron beams (see, e.g., [1, 2]). This is achieved by accelerating the electron beam, which is extracted from a cathode by a transversely and longitudinally shaped laser pulse, in RF cavities with very high electrical fields of up to 120 MV/m [1] to beam energies of several MeV within the first few centimeters after the cathode. This fast acceleration significantly reduces space charge induced emittance growth. Two major difficulties arise with scaling this scheme to high beam currents. The first one is the fact that high accelerating fields lead to a significant heating of the cavity surfaces due to resistive energy losses which causes thermal stress and increases the operational costs. The second one is the large amount of power which needs to be transferred onto the electron beam at high beam currents. At an energy of 5 MeV and an average current of 100 mA, for example, the beam power corresponds to 0.5 MW.

These technical implications have the consequence that in all currently existing high average current injectors, significantly lower electrical fields than in pulsed RF guns are used. In the following, we will give an overview of the most important gun schemes. The electron bunches are gener-

ated by photo-emission from a cathode material in all of these schemes, except for the diamond amplifier, which we will discuss at the end of this article.

In order to reduce the required laser power, cathode materials with a high quantum efficiency in the region of several percent are needed. Three types of cathode materials are commonly used: GaAs,  $K_2CsSb$  and  $Cs_2Te$ . The first two have the advantage that green light can be used for the photo-emission process rather than ultra-violet light, which is required for  $Cs_2Te$ . GaAs, however, requires a very good vacuum to avoid a lifetime degradation due to ion back-bombardment.

## DC GUNS

In DC guns [3], a constant electrical potential is applied between cathode and anode. Field emission limits the achievable electrical fields, and, with current designs, the obtained average fields are below 10 MV/m.

Figure 1 shows a schematic of a DC gun developed at JAEA. While the conceptual layout is very similar compared to other existing gun design, the main difference is the use of a segmented ceramic insulator. This insulator is protected from the support rod, which applies the high-voltage to the cathode electrode, by metallic guard rings. These guard rings prevent field emission bursts from di-

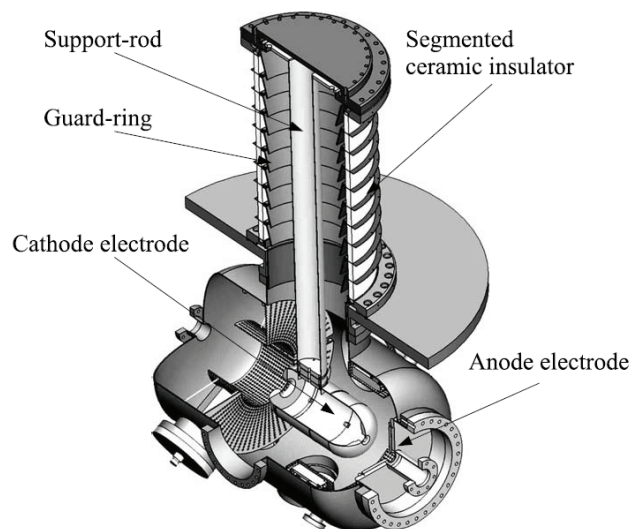

Figure 1: Design of a DC gun in which a segmented insulation ceramics with guard-rings is applied to prevent field emission bursts damaging the ceramics (from [4]).

\* florian.loehl@cornell.edu

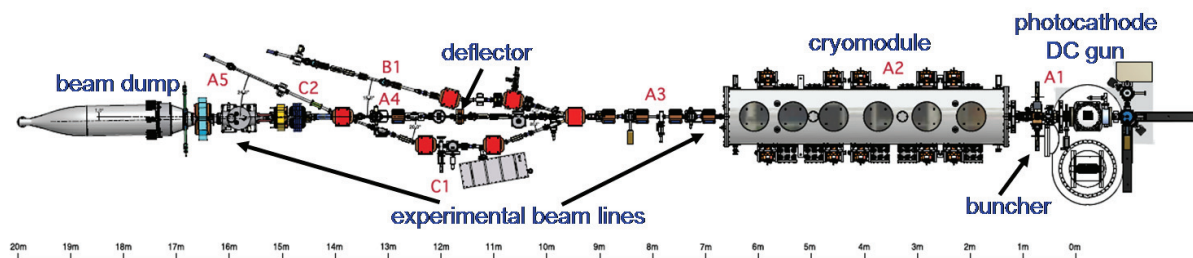

Figure 2: Schematic of the Cornell high current injector consisting of a DC gun, a buncher cavity, a cryomodule containing five 2-cell superconducting 1.3 GHz cavities, subsequent beam lines for a beam characterization followed by a high power beam dump.

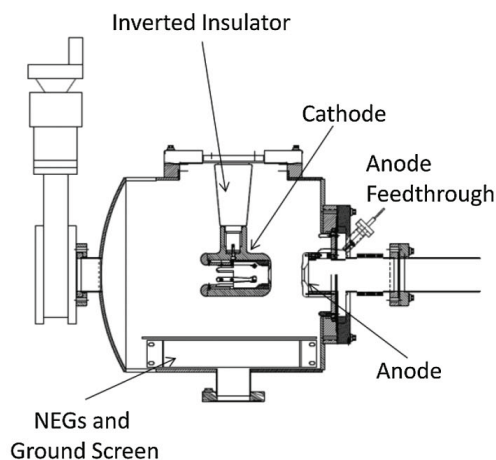

Figure 3: Schematic of an “inverted” DC gun (from [6]).

rectly hitting and possibly damaging the insulator, which in many other designs have limited the achievable gun voltage. Although so far the design has only been high-voltage tested, the initial results presented in ref. [4] are very promising. High voltage processing up to 550 keV and stable operation at 500 kV - the design voltage of this gun - was achieved over 8 h. Cornell is currently working on a similar design with larger insulator dimensions, which is intended to reach a gun voltage of up to 750 kV.

### *Inverted DC Gun*

The likelihood of experiencing field-emission increases with the surface area, which in conventional DC guns is quite large due to the support-rod. In 1994, Breidenbach et al. presented an alternative design in which the ceramic insulator is tapered and extends into the vacuum chamber [5]. In such a design, commonly referred to as an “inverted” DC gun, the surface area is substantially reduced. The spin-polarized GaAs photo-emission gun from Jlab, depicted in Fig. 3, is an example of such an “inverted” gun. Although so far no high voltage, high current gun exists with this design, the concept is very promising and work is ongoing to

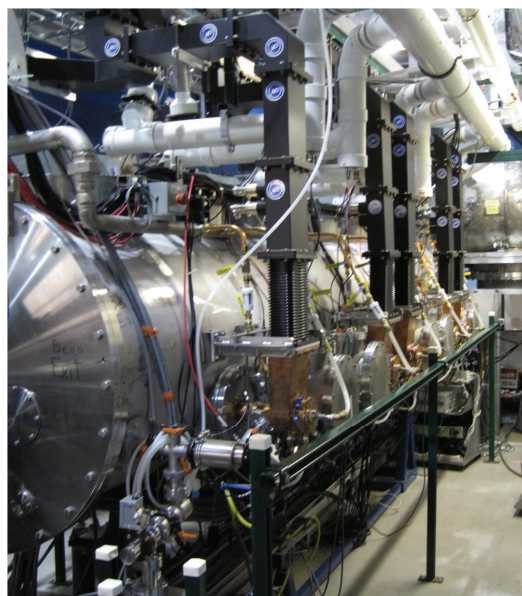

Figure 4: Superconducting booster module of the Cornell ERL injector, capable of providing beam powers of up to 500 kW via five two-cell cavities.

scale this concept to higher gun voltages [7].

### *Superconducting Booster Module*

Since the kinetic beam energy out of a DC gun is less than about 0.5 MeV, such a gun is typically followed by a superconducting booster module as shown in Fig. 4. Figure 2 shows a schematic of the Cornell high current injector, consisting of a DC gun, a buncher cavity, and a cryomodule containing five two-cell 1.3 GHz Niobium cavities. The DC gun is currently operated at 350 kV, but should eventually be operated at 500–600 kV. From a GaAs cathode, a flat-top electron beam with a FWHM duration of 30-40 ps is generated. Accelerating this beam at the zero-crossing of the buncher cavity in combination with the acceleration in the cryomodule yields a final bunch duration of around 1-3 ps (rms). The final beam energy is be-

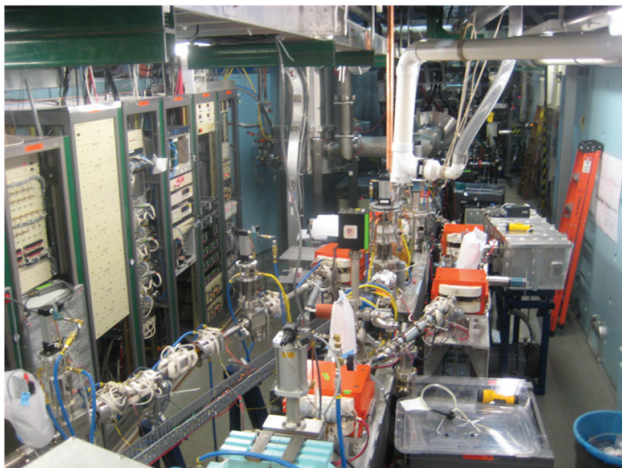

Figure 5: Diagnostics section of the Cornell ERL injector, including emittance measurement systems, a transverse deflecting cavity to study the longitudinal phase space, several view-screens, high current wire-scanners (not yet commissioned), as well as BPMs and beam loss monitors.

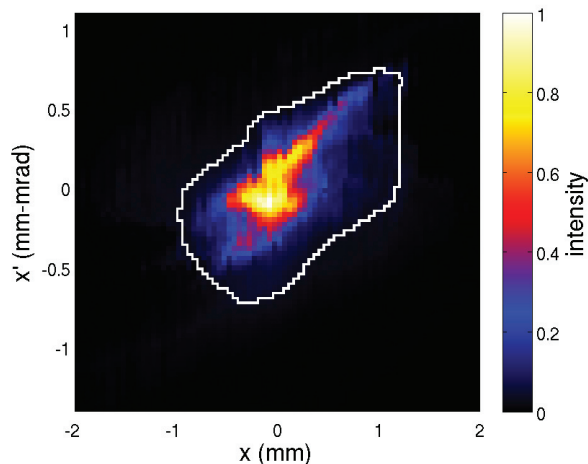

Figure 6: Horizontal phase space distribution measured at the high current Cornell ERL test injector for  $q = -77$  pC,  $E_{\text{kin}} = 9.7$  MeV during the first commissioning. The normalized rms emittance is  $\varepsilon_x = 2.7$  mm mrad, dominated by a beam halo. For the beam core containing 90 % of the particles (indicated by the white line), we receive  $\varepsilon_{x,90} = 1.6$  mm mrad.

tween 5 and 15 MeV and the design beam current is limited by the symmetrical power couplers for the cavities, which can handle up to 100 kW per pair, 50 kW each. This yields possible beam currents of up to 100 mA at an energy gain of 5 MeV and 33 mA for 15 MeV energy gain in the module. In initial tests, beam currents of up to 9 mA could be reached for short durations. The main limitation was beam loss caused by instabilities of the high-voltage gun power supply. The power supply is currently back at the company for upgrades.

## 07 Accelerator Technology

### T29 Subsystems, Technology and Components, Other

The booster module is followed by a sophisticated diagnostics section to study the beam properties (see Fig. 5). Recently, initial measurements of the transverse beam emittance have been carried out after major modifications<sup>1</sup> of the cryomodule were completed earlier this year. The measurements were taken at a beam energy of 10 MeV and at a bunch charge of 77 pC, which corresponds to a beam current of 100 mA at a 1.3 GHz bunch repetition rate. For the measurements, a 50 MHz drive laser and 0.3  $\mu\text{s}$  long macro-pulses at a rate of 1-2 kHz have been used, in order to reduce the power at the slits of the emittance measurement system. A normalized horizontal emittance of  $\varepsilon_x = 2.7$  mm mrad was measured, which was dominated by a beam halo (see Fig. 6). For the beam core containing 90 % of the particles, the rms emittance is  $\varepsilon_{x,90} = 1.6$  mm mrad. In these measurements, many parameters were not yet optimized. The ultimate goal at this bunch charge is an emittance of  $\varepsilon_x = 0.3$  mm mrad, which according to simulations is feasible with the design parameters of the injector [9].

## NORMAL-CONDUCTING CW RF GUNS

Normal-conducting RF guns can, with proper cooling, be operated in a continuous-wave (CW) mode. The electrical fields, however, have to be significantly reduced compared to state-of-the-art pulsed RF guns. The as yet highest demonstrated average beam current [11] was generated with a normal-conducting gun operating at a duty cycle of 25 %. In a 433 MHz gun, D. Dowell et al. were able to extract an average beam current of 32 mA from a  $\text{K}_2\text{CsSb}$  multi-alkali cathode. A beam energy of 5 MeV and a normalized beam emittance of 20 to 40 mm mrad was obtained for bunch charges of 1 – 7 nC.

Even higher beam currents are feasible with an improved, state-of-the-art cooling system. Los Alamos / AES is working on a normal-conducting gun operating at a frequency of 700 MHz which is designed to deliver beam currents of 100 mA and more with bunch charges of 3 nC and emittances of 7 mm mrad [10].

For FEL injectors, which do not require the highest beam current but still MHz bunch repetition rates, the approach shown in Fig. 7 is very interesting [12, 13]. This gun, designed at the Lawrence Berkeley National Laboratory, operates at a frequency of 187 MHz and at bunch repetition rates of up to 1 MHz. The field at the cathode is greater than 10 MV/m and simulations predict normalized emittances from below 0.1 mm mrad for a few tens of picocoulombs to 1 mm mrad for bunch charges of 1 nC. One advantage of the low frequency is the fact that the RF oscillation happens on such a slow time-scale that the electron bunch almost experiences a DC field, so that problems due to an RF curvature can be avoided.

<sup>1</sup>It turned out that several types of material applied to absorb higher order field-modes, which are excited by the electron beam, charged up. These had to be removed [8].

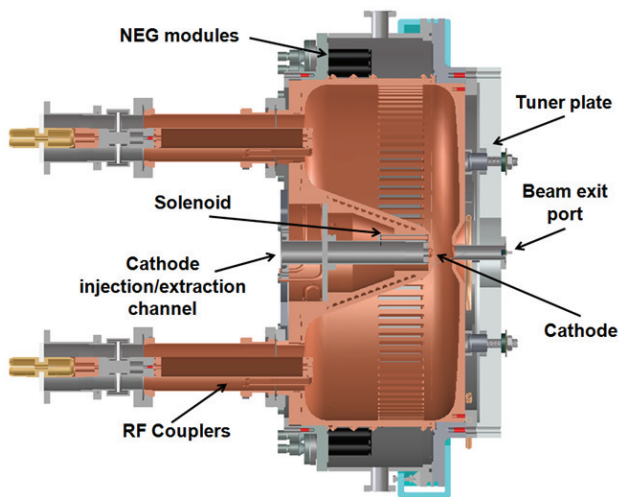

Figure 7: Low frequency, normal-conducting CW gun developed at LBNL [12, 13].

## SUPERCONDUCTING CW RF GUNS

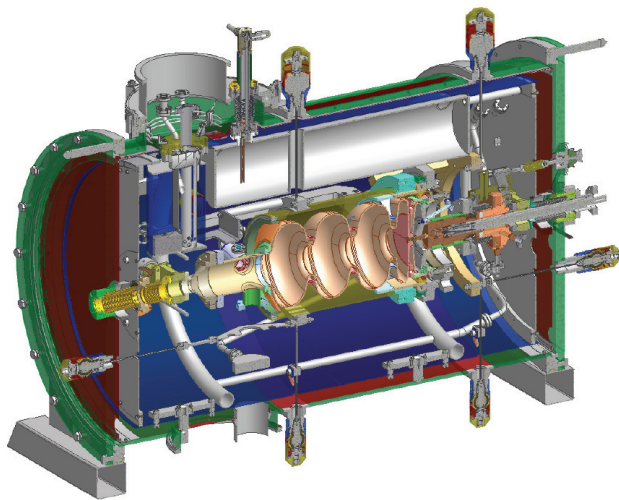

Figure 8: Schematic of the superconducting ELBE photoinjector (from [15]).

Superconducting RF guns have several advantages over normal-conducting guns which is why they are of increasing interest to the community. Among these advantages are almost no heating by resistive wall losses, resulting in lower operating costs and improved vacuum due to a reduced outgassing rates, which allows for vacuum-sensitive cathode materials. The vacuum is further improved by cryogenic pumping in the gun itself. Finally, a major advantage is that superconducting guns potentially allow for higher electrical fields than in DC guns or CW normal-conducting guns.

A lot of pioneering work on superconducting guns has been carried out at the Forschungszentrum Rossendorf which also operated the first superconducting RF gun [14], as well as at the Peking University. Figure 8 shows a

schematic of the superconducting ELBE photoinjector [15] which reaches a maximum average current of 1 mA at a bunch charge of 77 pC. Currently, the peak electric field is limited to 18 MV/m resulting in a normalized beam emittance of 2 mm mrad at a 77 pC bunch charge. With a new high gradient cavity, peak fields of up to 50 MV/m are envisioned, which will decrease the beam emittance by a factor of two [15]. The ELBE injector uses  $\text{Cs}_2\text{Te}$  as a cathode material.

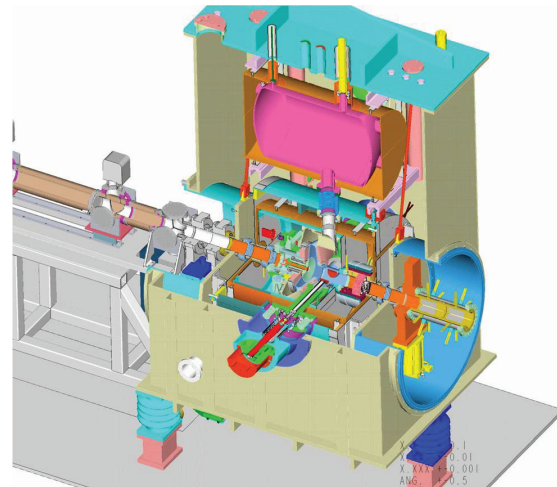

Figure 9: High-current superconducting gun developed at BNL (from [16]).

The Brookhaven National Laboratory is currently developing a high current superconducting RF gun which aims for beam currents of up to 500 mA at an energy of 2 MeV (see Fig. 9). It operates at a frequency of 704 MHz, which is also the aspired bunch repetition rate. The lower cavity frequency compared to frequencies of 1.3 GHz or 1.5 GHz used elsewhere makes it easier to put large amounts of power into the cavity and, due to a stiffer cavity, decreases the sensitivity to microphonics. It is intended to be operated at bunch charges of up to 0.7 nC with emittances of 1.4 mm mrad in a high current mode and up to 5 nC with an emittance of around 5 mm mrad in a high charge operation mode [16]. A major difficulty at the envisioned high beam currents will be the cathode material. One of the options is a diamond amplifier, which we will discuss next.

## DIAMOND AMPLIFIER

In a high current injector, the power requirements on the drive-laser get very demanding, even when cathode materials with quantum efficiencies in the several percent range are used. An interesting concept which might allow for a significant reduction in the laser power requirements is a diamond amplification stage [17, 18]. The concept is depicted in Fig. 10: a low charge electron bunch is generated in a primary photo-cathode. The emitted electrons are accelerated by a voltage of several keV and sent onto a thin diamond crystal. There, the primary electrons transfer

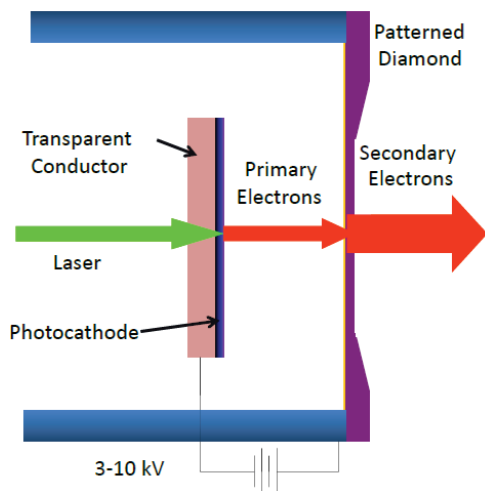

Figure 10: Principle of the diamond amplifier (from [18]).

their energy to carriers, which drift at the diamond saturation velocity of around  $0.2 \mu\text{m/ps}$  through the diamond. Secondary electrons are emitted after a corresponding drift-delay and accelerated by the primary gun voltage. Depending on the energy of the primary electrons, the charge amplification by the diamond can exceed a factor of 200 [18].

## SUMMARY

We have summarized the work in the community on high repetition rate, high brightness and high current electron sources and have discussed the most important schemes: DC guns, normal-conducting CW RF guns, and superconducting CW RF guns. A lot of progress has been made in recent years on all of these. DC guns operating at gun voltages of 500 kV and above are becoming a reality and currently, the first DC gun based injector designed to produce the beam quality and beam current required by a hard x-ray ERL is being commissioned. Different types of normal-conducting CW RF guns have been designed to deliver either large beam currents of 100 mA and more at bunch charges of several nC, or, exceptionally low beam emittances at lower bunch charges from tens of picocoulombs to 1 nC. Significant progress has also been made on superconducting RF guns, which already today deliver small beam emittances and beam currents of up to 1 mA. Developments on superconducting RF guns delivering beam currents of up to 500 mA are ongoing. An interesting concept to increase the bunch charge generated at the photocathode, the diamond amplifier, might help reaching these ambitious goals.

This work has been supported by NSF grants PHY-0131508 and DMR-0937466.

## REFERENCES

- [1] R. Akre, *et al.*, "Commissioning the Linac Coherent Light Source injector", *Phys. Rev. ST Accel. Beams* **11**, 030703 (2008).
- [2] M.Krasilnikov, *et al.*, "Recent electron beam measurements at PITZ with a new photocathode laser system", *Proceedings of PAC09*, Vancouver, BC, Canada, 2009.
- [3] C.K. Sinclair, *et al.*, "A 500 kV photoemission electron gun for the CEBAF FEL", *Nucl. Instrum. Methods Phys. Res., Sect. A* **318**, 410-414, (2010).
- [4] Ryoji Nagai, *et al.*, "High-voltage testing of a 500-kV dc photocathode electron gun", *Rev. Sci. Instrum.* **81**, 033304 (2010).
- [5] M. Breidenbach, *et al.*, "An inverted-geometry, high voltage polarized electron gun with UHV load lock", *Nucl. Instrum. Methods Phys. Res., Sect. A* **350**, 1 (1994).
- [6] P.A. Adderley, *et al.*, "Load-locked dc high voltage GaAs photogun with an inverted-geometry ceramic insulator", *Phys. Rev. ST Accel. Beams* **13**, 010101 (2010).
- [7] F. Hannon, "Jlab FEL Photoemission DC Guns", presentation at FLS2010 workshop, 2010.
- [8] M. Liepe, "Latest Results and Test Plans from the 100 mA Cornell ERL Injector SCRF Cryomodule", this conference, 2010.
- [9] I. V. Bazarov and C. K. Sinclair, "Multivariate optimization of a high brightness dc gun photoinjector", *Phys. Rev. ST Accel. Beams* **8**, 034202 (2005).
- [10] S.S. Kurennoy, *et al.*, "Development of photoinjector RF cavity for high-power CW FEL", *Nucl. Instrum. Methods Phys. Res., Sect. A* **528**, 392 (2004).
- [11] D. Dowell, *et al.*, "First operation of a photocathode radio frequency gun injector at high duty factor", *Appl. Phys. Lett.*, **63** (15), 2035 (1993).
- [12] K. Baptiste, *et al.*, "A CW normal-conductive RF gun for free electron laser and energy recovery linac applications", *Nucl. Instrum. Methods Phys. Res., Sect. A* **599**, 1 (2009).
- [13] J. Staples, F. Sannibale, S. Virostek, CBP Tech Note 366, Oct. 2006.
- [14] D. Janssen, *et al.*, "First operation of a superconducting RF-gun", *Nucl. Instrum. Methods Phys. Res., Sect. A* **507**, 1-2 (2003).
- [15] R. Xiang, *et al.*, "Running experience of the superconducting RF photoinjector at FZD", *Proceedings of FEL2009 conference*, Liverpool, UK, 2009.
- [16] Ilan Ben-Zvi, "Superconducting RF high-brightness injectors R&D at BNL and Stony Brook University", presentation at FLS2010 workshop, 2010.
- [17] X. Chang, *et al.*, "Recent progress on the diamond amplified photo-cathode experiment", *Proceedings of PAC07*, Albuquerque, New Mexico, USA, 2007.
- [18] John Smedley, "Diamond amplifier - status and prospects", presentation at FLS2010 workshop, 2010.